

BASICS

Please take a moment to identify which headrail version you have and then follow the appropriate instructions.

A few simple tools are required:

- Measuring tape
- Carpenters Level
- Power drill or Phillips head Screwdriver
- 1/4" Hex head and/or Phillips driver bit

Additional fasteners other than those sent with your shading may be required depending on the mounting surface. Wallboard and plaster require the use of anchors such as expansion or toggle bolts. Brick, tile or stone need special plugs and drill bits. Remember to always pre-drill holes in wood to avoid splitting.

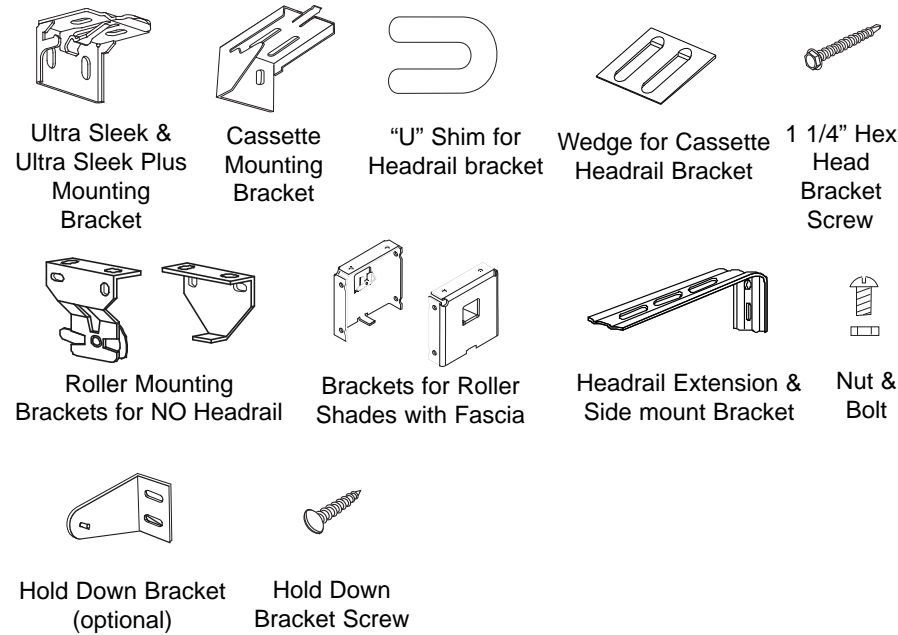

Step 1. BRACKET INSTALLATION

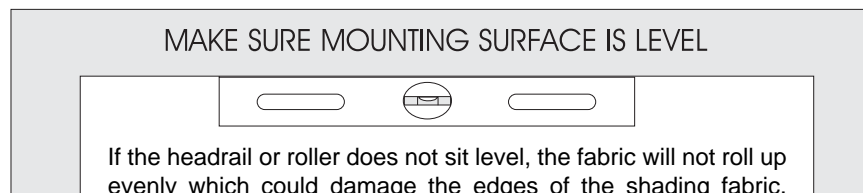

If the headrail or roller does not sit level, the fabric will not roll up evenly which could damage the edges of the shading fabric. Mount roller brackets as necessary, or use shims for headrail shades if necessary to level brackets.

For shades with headrail, the End brackets should be located with centerlines 2" in from each end. Depending on the width of the shading, necessary additional brackets may be evenly spaced between the two end brackets.

Shade width	# Brackets
Up to 40"	2
>40" - 72"	3
>72" - 84"	4
>84" - 114"	5

For shades with NO headrail, the installation brackets are always mounted so that the inner surfaces face each other. For Shades with a fascia, the brackets are mounted with the open end down. It is very important that the brackets are mounted so that the shade is level when installed.

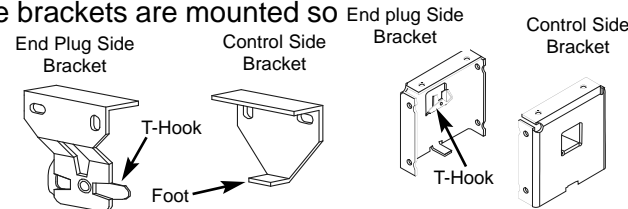

Inside Mount - Fascia or NO Headrail

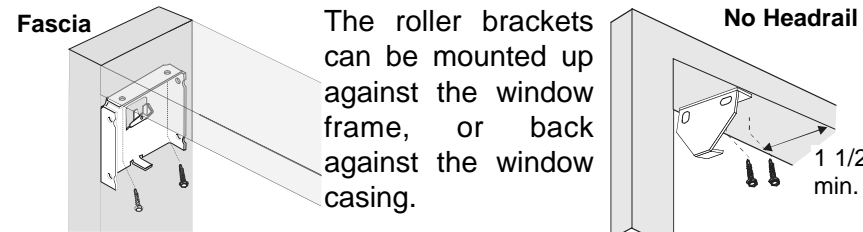

Inside Mount with Headrail

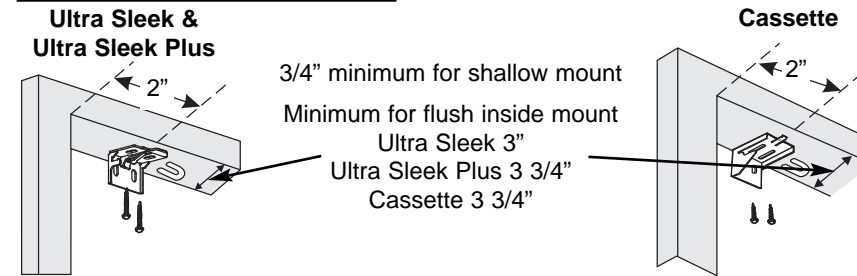

Use shims if necessary to ensure that the headrail is mounted level (included).

Fully Recessed Inside Mount with Cassette Headrail

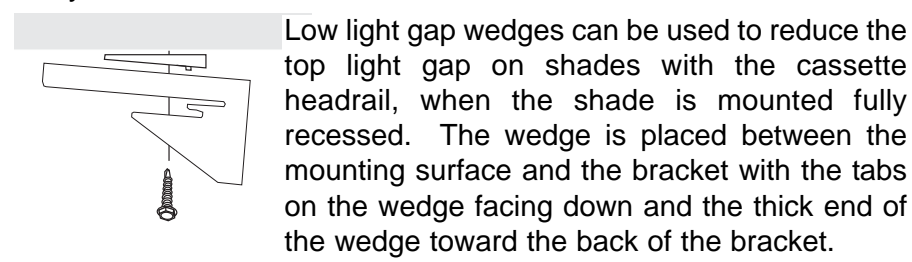

Outside Mount - Fascia or NO Headrail

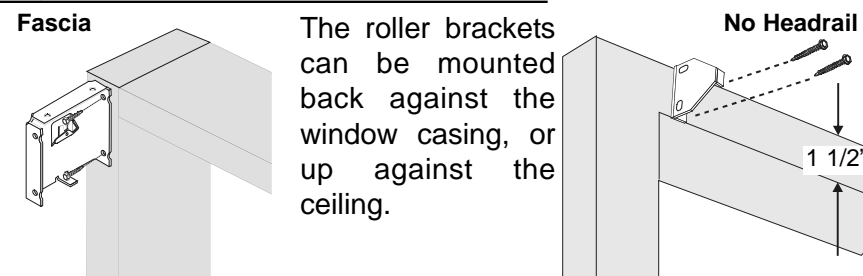

Outside Mount - with Headrail

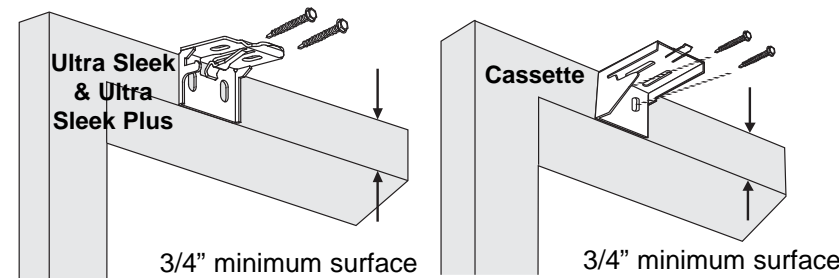

Extension and Sidemount - NO Headrail

The standard roller brackets can be mounted to the side of any opening utilizing the holes in the side of the bracket. The optional Extension roller brackets mount in the same manner as above, but allow an extra 1/2" of projection for the roller.

Extension Brackets (optional for Headrail shades)

Optional Extension Brackets are used to project the back of the shading up to 2 1/2" from the mounting surface. Attach the Standard Mounting Bracket to the Extension Bracket with the nut and bolt provided.

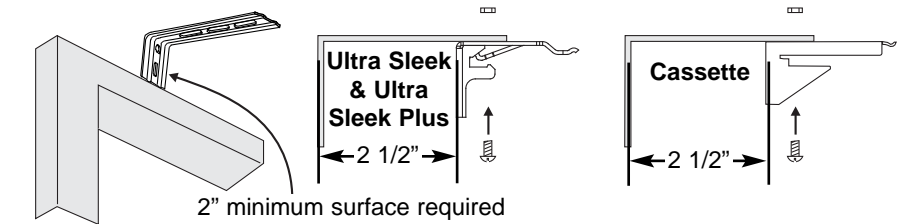

Side Mount (optional for Headrail shades)

Measure from window sill up to desired mounting position on each side of the window frame. Mark position. Mount Side Mount Brackets on each side of window frame as shown. Make sure to confirm that headrail will sit perfectly level. Once Side Mount Brackets are installed and properly positioned, attach the Standard Mounting Brackets using the nuts and bolts provided.

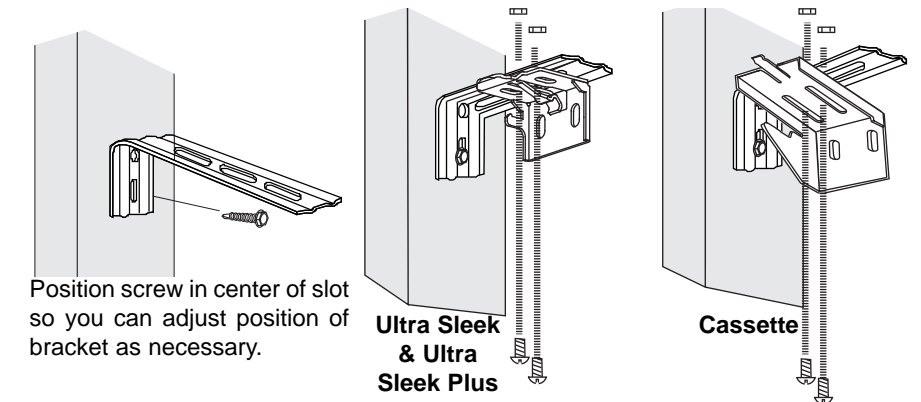

Step 2. HANGING THE SHADE

Shades with NO Headrail or Fascia

Once the brackets are secured and level, the fabric roll can be inserted. Make sure your hands are clean to avoid soiling the fabric.

While facing the inside of the shade, be sure the clutch and roller end plug are inserted into the roller. Hold the shade with the bottom of the clutch facing the floor, and the beaded cord hanging straight down.

Insert the foot of the control-side bracket into the slotted center hole of the clutch. Set nub of the end plug into the V of the support bracket. Rotate the T-hook on the support bracket to engage over the nub on the idler and secure the fabric roll.

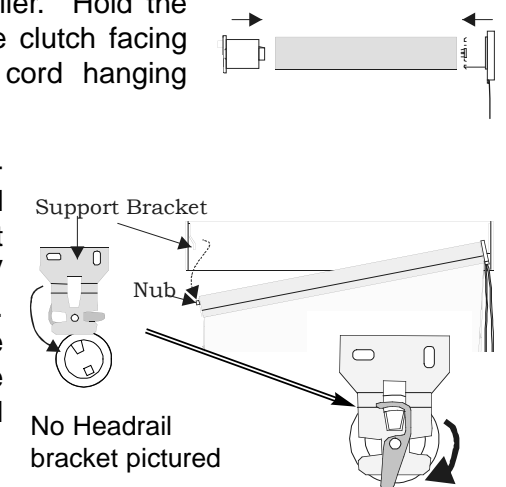

Shades WITH Headrail

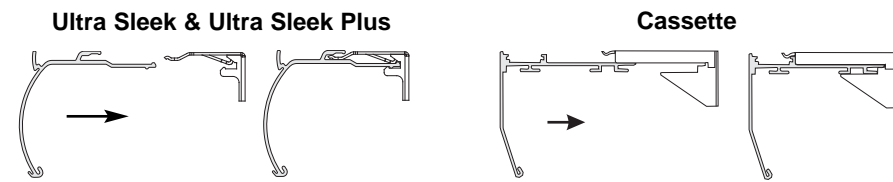

Push the rail back until it is fully engaged.

Un-Install Headrail

To remove the shading, partially lower the shading and insert a flat head screwdriver as shown. Twist the screwdriver until the headrail disengages from the bracket.

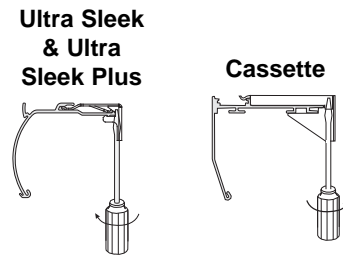

Step 3. ATTACHING FASCIA PANEL (IF ORDERED)

Attach the fascia by first hooking the top lip of the fascia panel onto the bracket as shown.

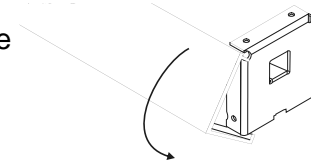

Swing the bottom of the fascia panel towards the bracket and gently press at the bottom of the panel until the lip on the fascia engages and snaps lock to the bracket.

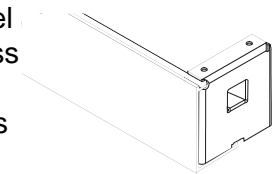

Step 4. CHILD SAFETY

The American National Standard for Safety of Corded Window Covering Products (ANSI) requires the use of a cord tie down (cord tensioner) on all continuous loop cord systems. The use of such a device is intended to significantly reduce the occurrence of infant or small child strangulation injuries or deaths resulting from the looped pull cords on various window treatment products.

Your window shade has arrived with the cord tensioner positioned near the head rail to comply with current WCMA child safety standards. The cord tensioner must be mounted and secured before the window shade will operate correctly. To position the tensioner, grasp the screw hole and pull down to release the lock. Pull the cord through the tensioner until the tensioner is at the bottom of the cord loop.

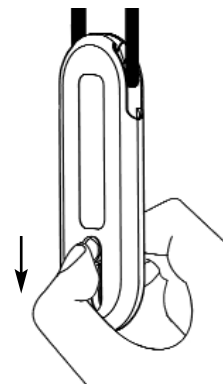

Follow the instructions included in the Tensioner Bracket Packet.

Step 5. HOLD DOWN INSTALLATION (optional)

Optional Hold Down Brackets are mounted with the supplied screws. With the shade at its proper drop, place the pin of each Hold Down into the hole in each End Cap and mark the screw holes. Make sure the pins are level and aligned. Raise the shade, then screw the Hold Down Bracket into the mounting surface.

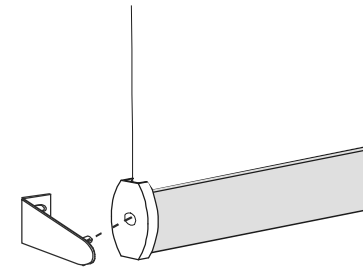

Step 6. SKEW ADJUSTMENT (if necessary)

If the shade does not raise evenly, first make sure the mounting brackets are mounted level with each other.

If the shade is level, pull the shade all of the way down. Prepare a strip of masking tape approximately 5" long. On the side of the shade opposite of the skewing direction, and as close to the end of the roller as possible, lift the fabric toward the back of the shade using your fingers and slide the tape with the sticky side facing the roller up as far as possible. The tape is to be running parallel to the roller.

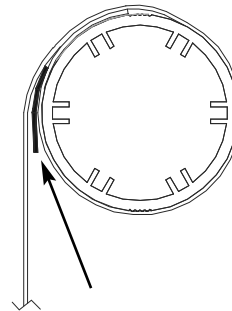

Roll the shade up and check for skewing. If the shade is still skewing, add another strip of tape on top of the first one. If the shade is now skewing to the opposite direction, tear off about 1" of tape from the last strip installed. The tape is to be torn from the end closest to the center of the shade.

CLEANING AND CARE

Occasional light vacuuming with a soft bristle attachment or gentle feather dusting is all that is required to keep your roller shades looking fresh and neat. Most roller shades may also be ultrasonically cleaned, except those made with Phifer SheerWeave fabrics.

Phifer SheerWeave fabrics are easy to maintain and only require occasional vacuuming with a soft brush attachment or washing with mild soap. Soak a sponge or damp cloth with the soapy solution and gently wipe or blot the stain from the fabric. To dry, allow the shade to air dry completely before raising.

If the shading has any wrinkling, lower the shade and leave in the lowered position for 5 to 7 days. The heat from the sun will smooth out any light wrinkles.

Installation Instructions

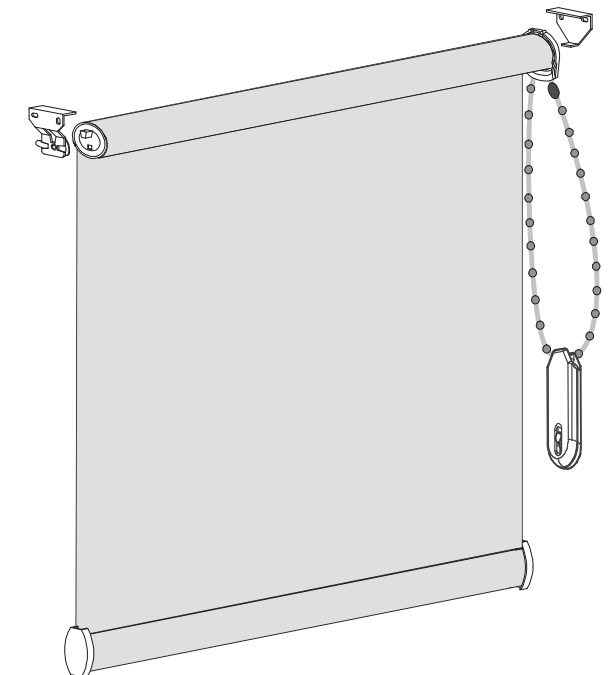
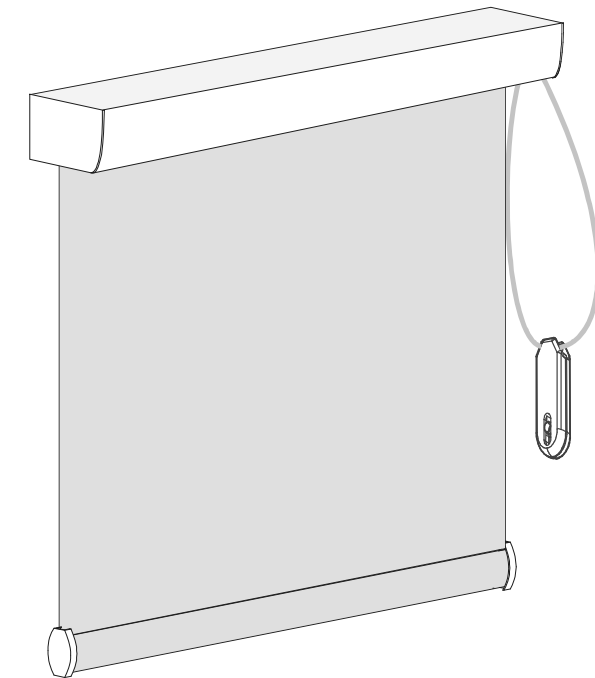

Roller Shades