

Cellular Slider

Installation Instructions

GETTING STARTED

Remove the shade from the package. Keep the packaging until the shade operates to your satisfaction.

Locate the packaging label attached to the side or end of the shipping carton which contains your shade information.

Read these instructions all the way through to acquaint yourself with the installation procedures.

Determine Your Shade Type

Installation for Vertical Honeycomb shades varies based on the design of your shade, the valance type, and the manner in which you are mounting your shade.

Refer to the packaging label to determine each of the following:

Determine which Vertical Honeycomb design you are installing: left stack, right stack, center stack, split stack (center opening), or Dual Panel.

Determine if your shade is an inside mount (IB-mounting inside the window casement), or outside mount (OB-mounting outside the window casement).

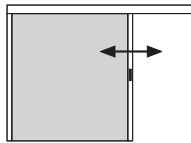

Left Stack
1 Stationary Rail
1 Moving Rail

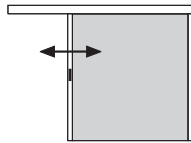

Right Stack
1 Stationary Rail
1 Moving Rail

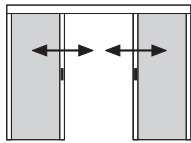

Split Stack and Dual Panel
2 Stationary Rails
2 Moving Rails

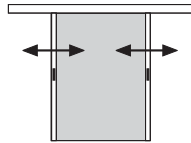

Center Stack
No Stationary Rails
2 Moving Rails

MATERIALS SUPPLIED WITH THE ORDER

Check to make sure you have all the materials listed for the number of shades you are installing and for the type(s) of installation. The contents of your hardware package may vary depending upon how the shade was ordered and whether the shade is mounted inside or outside the window or door opening.



Installation Brackets



Shim (Inside Mount)

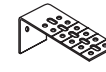

Extension Bracket (optional)



Spacer Block (optional)



Valance Clips



Stationary Bottom Rail Bracket



Inside Mount Adapter



Handle and Screws



Snap Pin



Aluminum Valance



No. 6 Hex Head Screw (Provided)



Wall Anchors, Expansion Bolts (Not Provided)



Sheet Metal Screws (Not Provided)

TOOLS REQUIRED

- Flat Blade and Phillips Screwdrivers
- Level
- Measuring Tape
- Pencil
- Scissors
- Variable speed drill with assorted drill bits

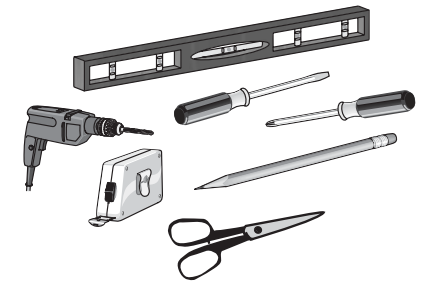

OUTSIDE MOUNT BRACKET INSTALLATION

Mounting The Brackets

Bracket Spacing

Measure and mark where to attach the installation brackets. Place installation brackets 8" in from the ends of the shade.

Space additional brackets evenly between the two end brackets.

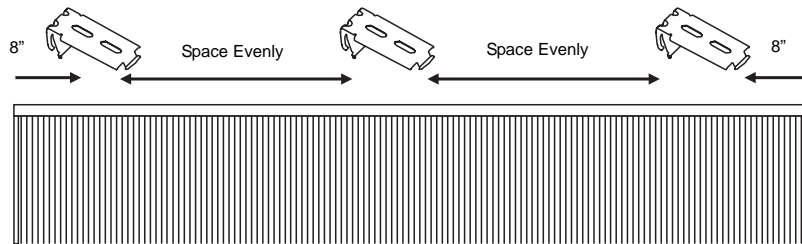

Outside Mount

Place the top of the mounting bracket a minimum of 5/8" from the top of the window opening.

NOTE: When mounting to drywall, you must use a wall anchor.

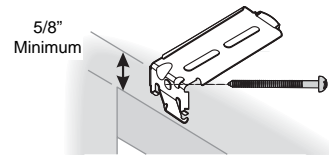

To locate where to place the top of the bracket, take the ordered shade height and add to it the desired floor clearance.

The shade height can be found on the packaging label. If no label exists, contact your dealer.

Use a carpenter's level to ensure that the brackets are level and aligned.

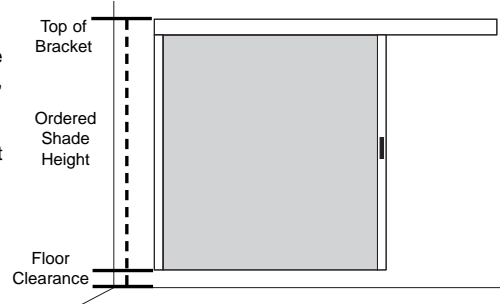

Outside Mount With Spacer Blocks

Each spacer block projects installation brackets 1/2" away from the mounting surface. Spacer blocks can be useful for above-trim installations.

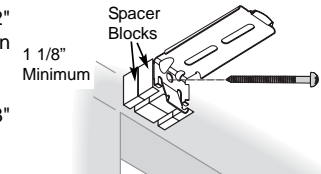

Place the top of the spacer block a minimum of 1 1/8" from the top of the window opening.

Position each spacer block with the solid side facing the mounting surface.

Mounting screws should be long enough to secure the bracket to the mounting surface.

Use a maximum of three spacer blocks per bracket.

NOTE: When mounting to drywall, you must use a wall anchor. The supplied screws are not long enough for use with spacer blocks. Please make sure the screws used are long enough to mount the rail securely.

NOTE: To locate where to place the top of the bracket, review the information under "Outside Mount", bottom of page 4.

Outside Mount With Extension Brackets

Extension brackets project installation brackets up to 2 1/2" away from the mounting surface, allowing additional clearance for obstructions such as window cranks, handles, and moldings.

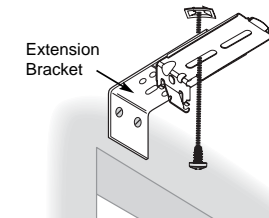

Use two screws to mount extension brackets.

NOTE: When mounting to drywall, you must use a wall anchor.

NOTE: To locate where to place the top of the bracket, review the information under "Outside Mount", bottom of page 4.

Level and align brackets with a level.

Attach installation brackets to the underside of extension brackets using the machine screws and speed nuts provided.

OUTSIDE MOUNT RAIL INSTALLATION

Install The Headrail

NOTE: The headrail will not slide in the mounting brackets once installed.

Measure and mark the centerpoint on the mounting surface.



Measure and mark the headrail's centerpoint.



Align the headrail to the matching marks, then install. Slip the headrail into the installation brackets so the front of the bracket slides under the front groove on the top of the rail. Gently roll the back of the headrail up and push back to snap into place.

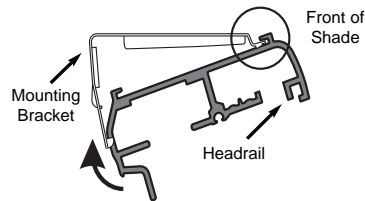

Prepare The Rails

Side Stack (Left And Right) And Split Stack

Install The Stationary Rail Bottom Bracket

NOTE: Do not insert the bracket completely. Leave at least 1/4" of the bracket showing below the stationary rail.

Insert the stationary rail bottom bracket into the bottom of the stationary rail. (For split stack, insert a bottom bracket into each stationary rail.) The base of the bottom bracket should extend toward the window.

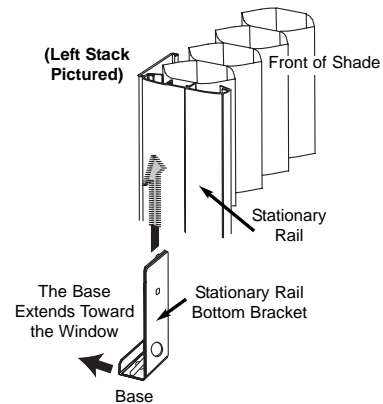

Assemble The Moving Rail(s)

Side Stack (Left And Right)

Insert the moving rail bracket into the moving rail. Install the snap pin through both the moving rail and the moving rail bracket.



Center Stack

Insert both moving rail brackets into the moving rails. Install the snap pins through both the moving rail and the moving rail bracket.

Split Stack

Insert both moving rail brackets into the moving rails (as shown above). Install the snap pins through both the moving rail and the moving rail bracket.

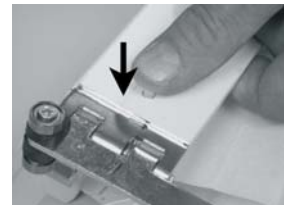

Install The Vertical Rails

Side Stack (Left And Right)

Remove the end plate from the stationary side of the headrail, if attached (for a left stack, remove the left end plate; for a right stack, remove the right end plate).

Pick up the rails and fabric as one unit and slide the rollers of the moving rail bracket onto the rear track of the headrail.

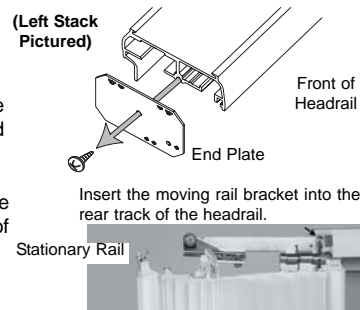

Slide the rail clips onto the back groove in the front of the headrail.



Install the stationary rail.

The stationary rail bracket has two slots at the top. The back tracks of the headrail fit into these slots.

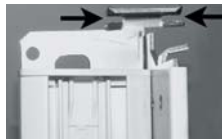

Insert the bracket into the back track of the headrail as shown. Twist the rail 90° to lock it in place.



Make sure the bracket aligns with the end of the headrail.



Install the cord tensioner by unwinding the cord from the end plate. Slide the cord tensioner into the channel at the front of the headrail.

NOTE: You will adjust the cord tensioner later.

Attach the stationary rail side end plate and the moving rail side end plate.

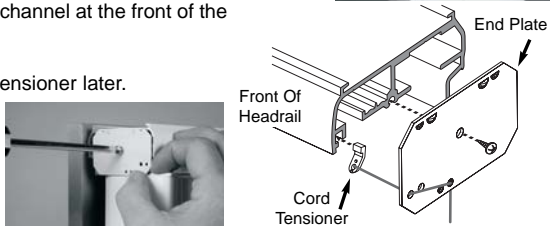

8

Center Stack

Pick up all the rails and fabric and slide the rollers of the right moving rail onto the left side of the headrail.



Slide the rail clips onto the back groove in the front of the headrail.

Slide the left moving rail bracket into the headrail.



Install the left end plate.

Install the cord tensioner.

Unwind the cord and spring from the right end plate.

Slide the cord tensioner into the channel at the front of the headrail.

Attach the right end plate.

NOTE: You will adjust the cord tensioner later.

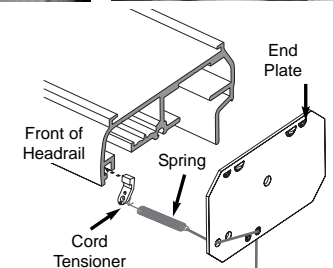

Split Stack

Remove the left end plate from the headrail.

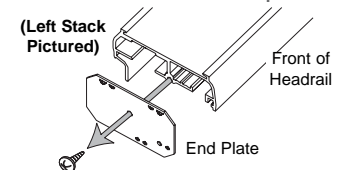

Insert the center pull plate in the center channel and screw in at the center point of the headrail. (The illustration at right references the placement of the center pull plate in the center groove. It still needs to be centered in the headrail before screwing down.)



9

Pick up the left set of rails and fabric and slide the rollers of the moving rail bracket onto the rear track of the headrail.



Slide the rail clips onto the back groove in the front of the headrail.



Install the stationary rail. The stationary rail bracket has two slots at the top. The back tracks of the headrail fit into these slots.

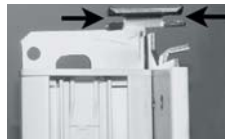

Insert the bracket into the back track of the headrail as shown. Twist the rail to lock it in place.



Make sure the bracket aligns with the end of the headrail.



NOTE: It may be necessary to use a screwdriver and mallet to move the bracket to the end of the headrail (see bottom of page 17).

Install the left end plate.

Install the right fabric panel and stationary rail in a similar fashion as previously described.



Install the cord tensioner by unwinding the cord from the end plate. Slide the cord tensioner into the channel at the front of the headrail.

Attach the right end plate.

NOTE: You will adjust the cord tensioner later.

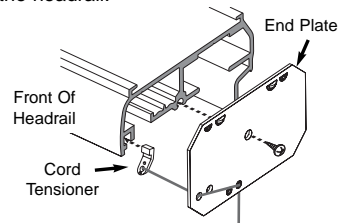

OUTSIDE MOUNT STATIONARY RAIL BOTTOM BRACKET ATTACHMENT

Secure The Stationary Rails

Side Stack (Left And Right) And Split Stack

Use a level to ensure that the stationary rail is exactly vertical when viewed from both the front and the side.



Secure the screw through the bracket and into the mounting surface.

Split Stack: Secure both stationary rail bottom brackets.

You may use an extension bracket to mount the stationary rail away from the wall. An extension bracket may be necessary if you used spacer blocks with the mounting brackets.

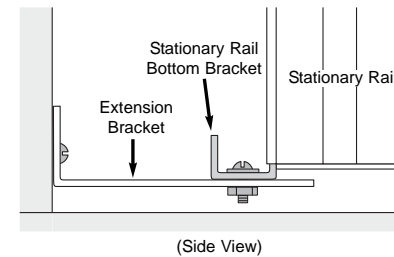

Go to page 23 for Final Adjustments.

INSIDE MOUNT BRACKET INSTALLATION

****NOTE: 'Traditional Install' is Strongly recommended for Inside Mount (page 18).****

Mount The Brackets

Bracket Spacing

Measure and mark where to attach the installation brackets. Place installation brackets 8" in from the ends of the shade. Space additional brackets evenly between the two end brackets.

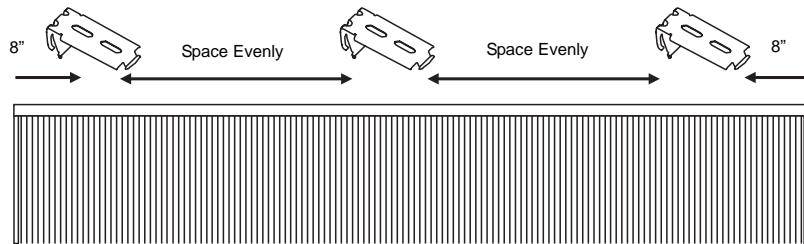

Attach the Bracket Shim

Attach the shim to the top of the mounting bracket. It snaps on and is held in place by the screw holes. Mount each bracket with an attached shim at the previously marked location. Use a level to ensure that the brackets are level and aligned.



Inside Mount

Position the installation brackets so the tops of the brackets attach to a flat horizontal surface. Measure and mark all bracket locations. Use the chart below for your measurements. Use a level to ensure that the brackets are level and aligned.



Minimum Depth for Inside Mount = 3/4"

Minimum Depth of Fully Recessed Inside Mount = 3 5/8"

NOTE: When mounting to drywall, you must use a wall anchor.

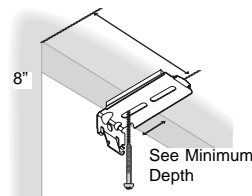

INSIDE MOUNT HEADRAIL PREPARATION

Install The Components Into The Headrail

Side Stack - Left Stack

See the illustration at right for the order of components as they are installed in the headrail.

Detach the rail clips from the fabric clips. To detach, twist the rail clip while holding the base of the fabric clip in place.

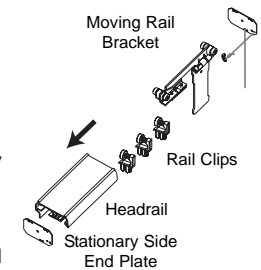
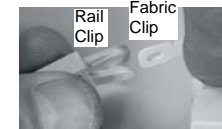
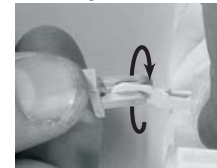

NOTE: Should the rail clip become slightly open, gently squeeze the prongs back together.

Tighten the stationary side end plate, which is loosely attached to the left (stationary) side of the headrail.

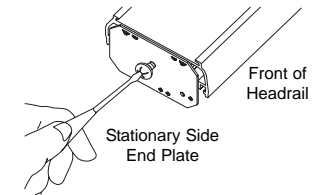

Slide the rail clips onto the back groove in the front of the headrail.



From the right side of the headrail, slide the moving rail bracket into the back track of the headrail with the front of the bracket going in first.

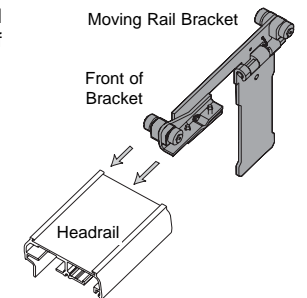

Unwind the cord wrapped around the right end plate. The cord tensioner is attached to the end of the cord.

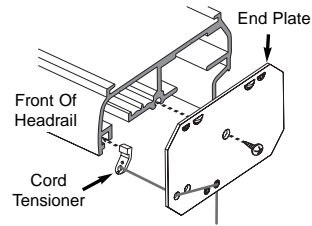

Slide the cord tensioner down the cord tensioner slot on the right end of the headrail.



Screw the cord tensioner end plate onto the headrail.

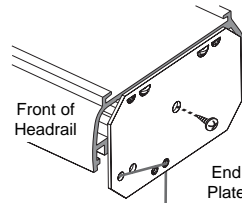

Side Stack - Right Stack

Follow the steps starting on page 13, except install the components from the left side of the shade.

See the illustration at right for the order of components as they are installed in the headrail.

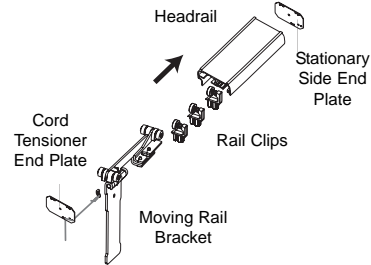

Center Stack

Follow the steps starting on page 13.

See the illustration at right for the order of components as they are installed in the headrail.

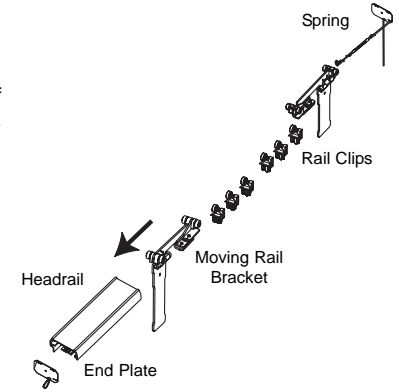

Split Stack

Follow the steps starting on page 13.

See the illustration at right for the order of components as they are installed in the headrail.

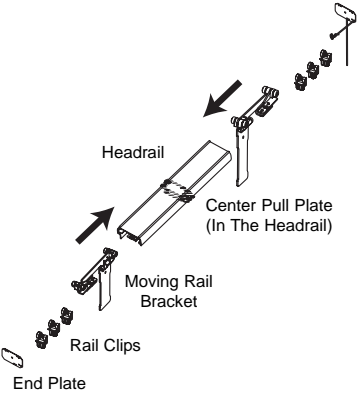

INSIDE MOUNT HEADRAIL INSTALLATION

Install The Headrail

Hold the headrail parallel to the installation brackets. The front of the brackets should be under the front groove on the top of the rail. Push the headrail straight up. Slide the headrail into the brackets until they click.

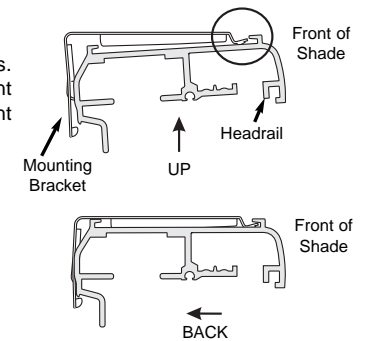

INSIDE MOUNT VERTICAL RAIL INSTALLATION

Preparing The Vertical Rails

Side Stack (Left And Right) And Split Stack

Install The Stationary Rail Bottom Bracket

NOTE: Do not insert the bracket completely. Leave at least 1/4" of the bracket showing below the stationary rail. Insert the stationary rail bottom bracket into the bottom of the stationary rail. (For split stack, insert a bottom bracket into each stationary rail.) The base of the bottom bracket should extend toward the window.

NOTE: Do not attach the bracket to the mounting surface at this time.



Center Stack

Center stack shadings do not have stationary rails. Skip this section and go to page 17, Install The Moving Rail Bracket(s).

Install The Vertical Rails

Side Stack (Left And Right) And Split Stack

Install The Stationary Rail(s)

Side Stack: Pick up all the rails and fabric as one unit.

Split Stack: Pick up all the left panel rails and fabric as one unit, repeat with the right panel of rails and fabric.

Install the stationary rail.

The stationary rail bracket has two slots at the top. The back tracks of the headrail fit into these slots.

Insert the bracket into the back track of the headrail. Twist the rail 90° to lock it in place.

TIP: Install the stationary rail as close to the end of the headrail as possible.

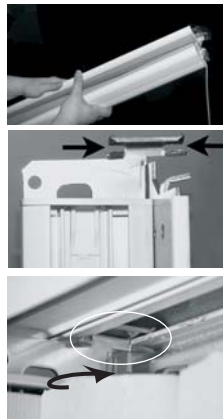
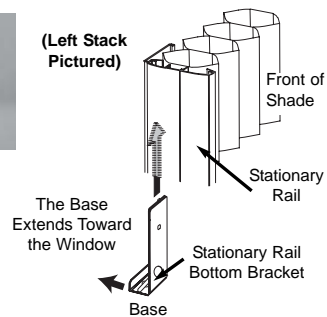

Install The Moving Rail Brackets

Side Stack (Left And Right), Split Stack, And Center Stack

Slide the moving rail bracket (located in the headrail) into the moving rail.

NOTE: The moving rail bracket is hinged to allow easier access for attaching it to the moving rail.

Install the snap pin through both the moving rail and the moving rail bracket.

NOTE: For center stack and split stack shades, repeat this step for the right moving rail.

Attach The Fabric Clips To The Rail Clips In The Headrail

Side Stack (Left And Right), Split Stack, And Center Stack

Insert the top of each fabric clip into the corresponding rail clip (located in the headrail).

NOTE: For split stack shades, repeat this step for the right fabric panel.

Center Stack Shades

Center stack shades have no stationary rails. Go to page 23 for Final Adjustments.

Verify The Stationary Rail Is Flush Against the End Plate

The stationary rail must be flush against the stationary rail end plate. If necessary, place the tip of a screwdriver against the top of the bracket and tap it gently with a hammer.

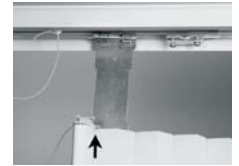

INSIDE MOUNT STATIONARY RAIL BOTTOM BRACKET ATTACHMENT

Secure The Stationary Rail(s)

Side Stack (Left And Right) And Split Stack

Use a level to ensure the stationary rail is exactly vertical when viewed from both the front and the side.



Secure the screw through the bracket and into the bottom of the mounting surface. See the next step if you ordered your shade with a cut-out or you prefer to secure the rail to the side.

Use the inside mount adapter to secure the stationary rail to the side of the casement.



NOTE: If you ordered your shade with a cut-out, such as for baseboards or other obstructions, you must use the inside mount adapter.

Align the screw hole of the adapter to face the window casement (or wall). Slide the inside mount adapter onto the stationary rail bottom bracket. Secure a screw through the inside mount adapter and into the casement.

TRADITIONAL MOUNT (BUILT ON THE FLOOR) BRACKET INSTALLATION

NOTE: For Outside Mounts: Follow the instructions on pages 4-5, for installing the installation brackets.

NOTE: For Inside Mounts: Follow the instructions on page 12 for installing the installation brackets.

NOTE: Larger installations will require two people.



Prepare the Rails

Gather and layout all the components for installation on a clean, cloth covered surface.

Side Stack (Left And Right) And Split Stack

Install The Stationary Rail Bottom Bracket

NOTE: Do not insert the bracket completely. Leave at least 1/4" of the bracket showing below the stationary rail.



Insert the stationary rail bottom bracket into the bottom of the stationary rail. (For split stack, insert a bottom bracket into each stationary rail.) The base of the bottom bracket should extend toward the window.



NOTE: Do not attach the bracket to the mounting surface at this time.

Install The Moving Rail Bracket

Side Stack (Left And Right)

Slide the moving rail bracket into the moving rail. Install the snap pin through both the moving rail and the moving rail bracket.



Center Stack

Slide the moving rail bracket into the moving rail. Install the snap pins through both the moving rail and the moving rail bracket.

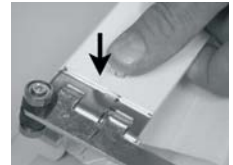

Split Stack

Slide the moving rail bracket into the moving rail. Install the snap pins through both the moving rail and the moving rail bracket.

TRADITIONAL MOUNT INSTALL VERTICAL RAILS

Left/Right Stack and Split Stack

Remove the end plate from the stationary side of the headrail, if attached. For a Left Stack, remove the left end plate; for a Right Stack, remove the right end plate.

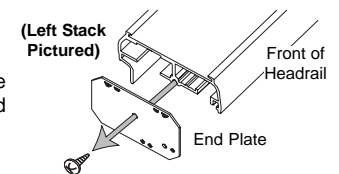

Split Stack

Insert the center pull plate in the center channel and screw in at the center point of the headrail. (The illustration at right references the placement of the center pull plate in the center groove. It still needs to be centered in the headrail before screwing down.)



Left/Right Stack and Split Stack

Gather all the rails and fabric and slide the rollers of the moving rail bracket onto the rear track of the headrail.

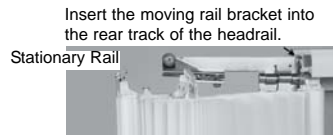

Slide the rail clips onto the back groove in the front of the headrail.



Install the stationary rail

The stationary rail bracket has two slots at the top. The back tracks of the headrail fit into these slots.

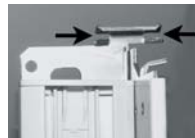

Insert the bracket into the back track of the headrail as shown. Twist the rail 90° to lock it in place.



Make sure the bracket aligns with the end of the headrail.



NOTE: It may be necessary to use a screwdriver and mallet to move the bracket to the end of the headrail (see bottom of page 17).

Attach the stationary rail side end plate.



Install the cord tensioner by unwinding the cord from the end plate. Slide the cord tensioner into the channel at the front of the headrail.



Attach the right end plate.

NOTE: You will adjust the cord tensioner later.

Attach the other end plate.



TRADITIONAL MOUNT HEADRAIL INSTALLATION

Outside Mount — Headrail Installation

Side Stack (Left And Right), Split Stack, And Center Stack

Install The Headrail

NOTE: The headrail will not slide in the mounting brackets once installed.

Measure and mark the centerpoint on the mounting surface.



Measure and mark the headrail's centerpoint.



Gather up all the rails and fabric as one unit.

Align the headrail mark to the matching mark on the mounting surface, then install.

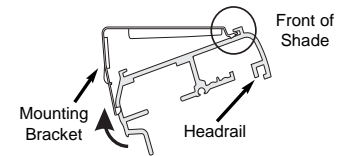

Slip the headrail into the installation brackets so the front of the bracket slides under the front groove on the top of the rail.

Gently roll the back of the headrail up and push back to snap into place.

Inside Mount — Headrail Installation

Install The Headrail

Gather up all the rails and fabric as one unit.

Hold the headrail parallel to the installation brackets. The front of the brackets should be under the front groove on the top of the rail. Push the headrail straight up. Slide the headrail into the brackets until they click.

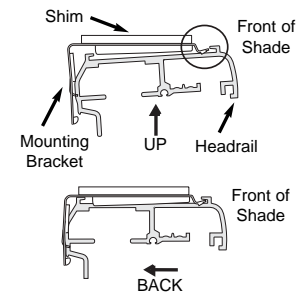

TRADITIONAL MOUNT STATIONARY RAIL BOTTOM BRACKET ATTACHMENT

Outside Mount

Side Stack (Left And Right) And Split Stack

Use a level to ensure that the stationary rail is exactly vertical when viewed from both the front and the side.

Secure the screw through the bracket and into the mounting surface.

You may use an extension bracket to mount the stationary rail away from the wall. An extension bracket may be necessary if you used spacer blocks with the mounting brackets.

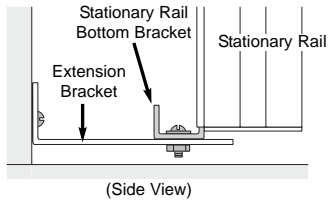

(Side View)



Inside Mount

Side Stack (Left And Right) And Split Stack

Use a level to ensure the stationary rail is exactly vertical when viewed from both the front and the side.

Secure the screw through the bracket and into the bottom of the mounting surface. See the next step if you ordered your shade with a cut-out or you prefer to secure the rail to the side.

Use the inside mount adapter to secure the stationary rail to the side of the casement.

NOTE: If you ordered your shade with a cut-out, such as for baseboards or other obstructions, you must use the inside mount adapter.

Align the screw hole of the adapter to face the window casement (or wall). Slide the inside mount adapter onto the stationary rail bottom bracket.

Secure a screw through the inside mount adapter and into the casement.

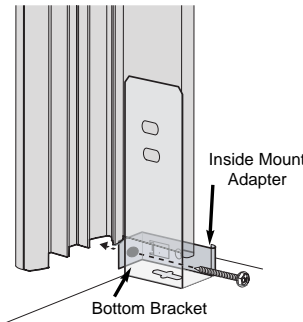
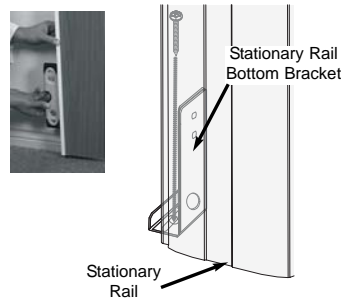

SHADE ADJUSTMENT

Remove Excess Cord

Pull on the end of the cord at the cord tensioner to release the slip knot. Slide the tensioner to a spot approximately 12" from the rail end. Pull cord to create tension. Re-tie a knot at the cord tensioner. Trim the excess cord.

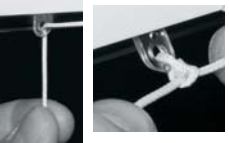

Adjust The Vertical Alignment

Check to see if the vertical rail is aligned. If not, locate the adjusting lever on the moving rail bracket.

TIP: When adjusting the moving rail, it is much easier to adjust if the cord tension is minimal. To fine-tune the adjustments, do not loosen the tension. Loosen the tension to make large angle adjustments only.



To Adjust The Bottom End Of The Moving Rail To The Right:

Loosen the left screw 1/2 turn, then tighten the right screw 1/2 turn. Repeat until the shade is properly aligned. After adjustment, tighten both screws completely.



To Adjust The Bottom End Of The Moving Rail To The Left:

Loosen the right screw 1/2 turn, then tighten the left screw 1/2 turn. Repeat until the shade is properly aligned. After adjustment, tighten both screws completely.



Test The Shade

Move the moving rail to check the shade tension. The moving rail should slide easily, yet there should be enough cord tension to hold the shade in place at any position.

Decrease the cord tension if the moving rail does not move smoothly. Increase the cord tension if the rail does not hold its position.

Adjust The Cord Tension

To tension: slide the cord tensioner away from the end plate until you feel resistance.

Continue to slide the cord in 1" increments to make the moving rail hold its position. Repeat if necessary.

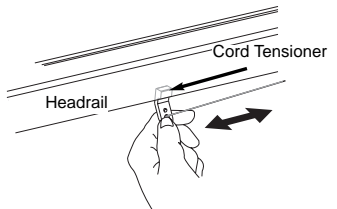

VALANCE AND HANDLE(S) ATTACHMENT

Aluminum Valance

Attach The Valance Clips To The Valance

Attach the valance clips to the valance as shown.

On wider shades, lay the two pieces of the valance on a flat surface and butt together.

Attach a valance clip at the seam to hold the two valances together.

Assemble The Returns Onto The Valance

Outside mounts and non-flush inside mounts only: Attach the valance return and the valance corner end cap to each end of the valance.

Attach The Valance To The Headrail

Keep a minimum of 3" between the end of the headrail and the valance clips. Be sure to avoid areas where the headrail attaches to the mounting brackets.

Slide the valance clip under the back lip of the headrail.

Rotate the valance down to snap the clips into place on the headrail.

TIP: Tap the valance at each clip to assure each clip is attached to the headrail.

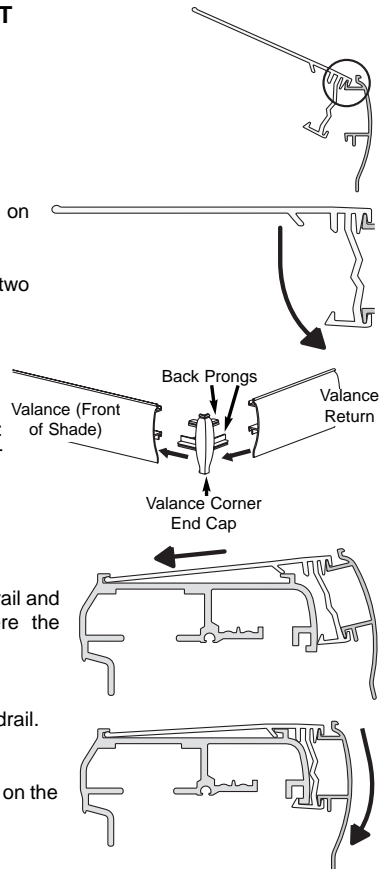

Attach The Handle(s)

If the handle is not already attached to the shade, do the following:

Position the handle so the holes on the flat portion of the handle are aligned with the screw holes on the moving rail. The curve of the handle should face out, away from the fabric.

Attach each handle to its moving rail using the provided screws. Holes are pre-drilled into each moving rail.

Headrail Removal

To remove the headrail, first remove the valance by popping the valance off of the headrail.

To remove the headrail, hold the headrail assembly and push back on the bottom tab of the mounting bracket to release the bottom edge of the headrail.

Roll the back of the headrail downward and out from the bracket.

CAUTION: Because the bracket is stiff, the headrail may be difficult to remove. Use a flat blade screwdriver wrapped in a soft cloth. Push the blade against the bottom tab of the mounting bracket and twist slightly to pop the rail off the bracket.

Be careful not to scratch the finish on the back of the headrail.

CARE AND CLEANING

Vertical Honeycomb shades are made of an anti-static, dust-resistant fabric which repels dirt and dust.

Dusting

Regular light dusting with a feather duster is all the cleaning that is needed in most circumstances.

Vacuuming

Use a hand-held vacuum with low suction for more thorough dust removal.

Spot-Cleaning

Prepare a solution of warm water and a mild detergent. Dampen a clean cloth in the solution and wring it out. Dab the spot with the dampened cloth until it is gone. Do not rub the fabric. Allow the shade to dry in the completely extended position (a closed shade).

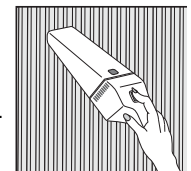
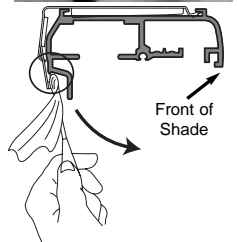

TROUBLESHOOTING PROCEDURES

Problem and Symptom/Solution

Q. *The shade binds or moves with difficulty.*

- A.** If the shade does not slide with ease, you may need to adjust the cord tension. Slide the cord tensioner away from the fabric stack slightly to decrease the tension.
A. Check that the cord is not pinched.

Q. *The shade does not stay in position.*

- A.** If the shade does not stay in position, you may need to adjust the cord tension. Slide the cord tensioner toward the fabric stack slightly to increase the tension.

Q. *The shade is not vertically aligned.*

- A.** Adjust the screws on the moving rail. To move the bottom of the rail to the right, loosen the left screw 1/2 turn and tighten the right screw 1/2 turn. To move the bottom of the moving rail to the left, reverse the process and loosen the right screw as you tighten the left.

Q. *The installation brackets do not allow enough clearance for the shade (to clear moldings or window cranks).*

- A.** Use an extension bracket or spacer blocks for mounting each installation bracket to allow adequate clearance for your shade.

Q. *On inside mount applications, there isn't enough room above the mounted installation brackets to angle and attach the headrail and/or the valance.*

- A.** Use a shim added to each installation bracket to provide additional space to attach the headrail and/or valance.

Q. *A fabric carrier needs to be reattached.*

- A.** Place each carrier between a pair of fabric cells. Align the hole in the fabric carrier with the hole in the fabric cells. Snap the carrier closed by pinching the two pieces of the carrier together from top to bottom.

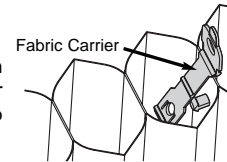

Q. *The cord tensioner does not lock into place.*

- A.** Using a small 1/8" flat blade screwdriver, scrape the paint from the inside of the channel used for the cord tensioner.
A. Place a valance bracket up against the cord tensioner to act as a stop preventing the tensioner from sliding.

Q. *The moving rail does not align with the stationary rail. The fabric seems to bow toward (or away) from the window.*

- A.** Take the moving rail (with center stack and split stack - take both moving rails) and gently move it toward the window, then away from the window, then back into the correct position. The fabric should align to this correct position.